

Drawing ID

TR-S5025X

Product Info.

Finish	Code
Polish	TR-S5025M
Satin	TR-S5025S
Texture Black	TR-S5025B

Dimensions

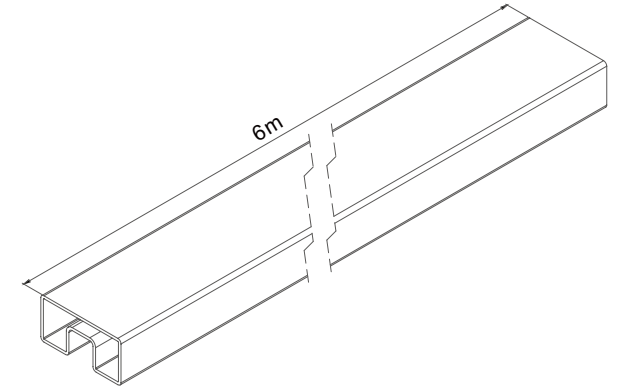
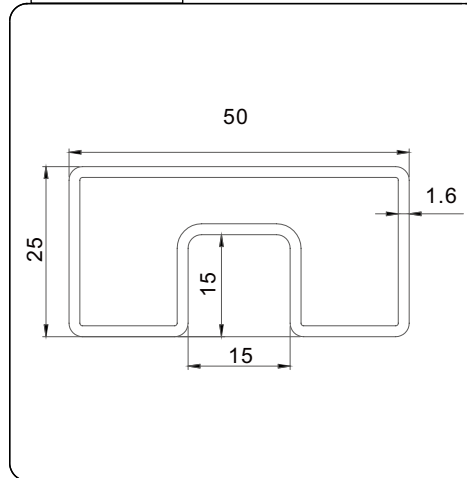

Instructions

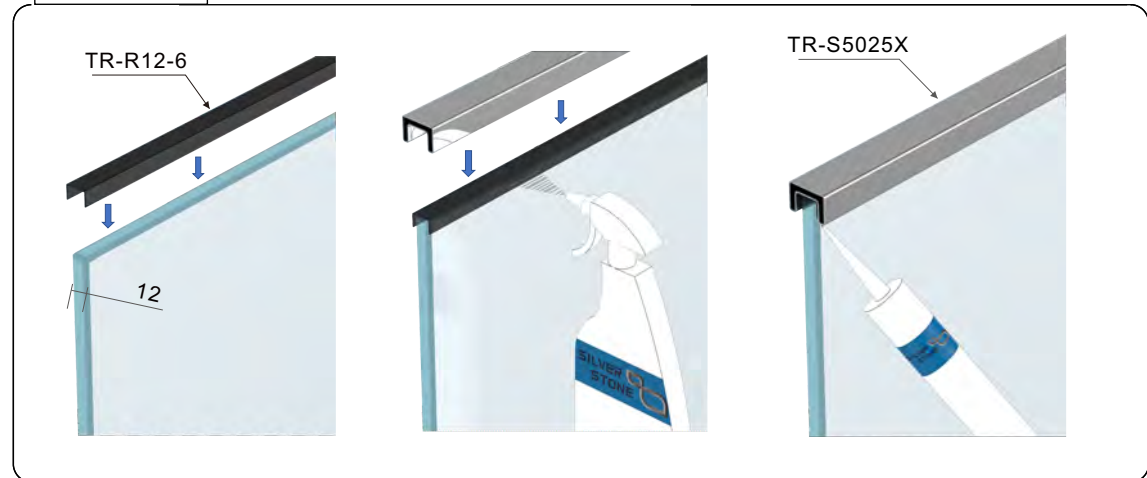

MATERIAL:

316L Stainless Steel

CATALOGUE AND DESCRIPTION:

- > Railing Systems
- > TR-S5025 Series
- > 50 x 25mm Square Top Rail

NOTES:

This drawing and or specification is the property of Silver Stone Hardware Pty Ltd - and must be returned to them on request. Unauthorised use may result in Legal Action. Its contents must not be made public, nor copied, nor used directly or indirectly in any way.

SILVER STONE HARDWARE PTYLID

56-62 Bryant Street, Padstow, NSW 2211
 T: (02) 9792 2955 M: 0452 526 680
www.silverstonehardware.com.au
sales@silverstonehardware.com.au